

Peltier-Type

Thermoelectric Bath

Series **HEB**

● Accurately controls the temperature of liquid in the bath.



Temperature stability: $\pm 0.01^{\circ}\text{C}$



Temperature distribution: $\pm 0.02^{\circ}\text{C}$ in the bath

- Environmentally friendly and refrigerant-free
- Heaterless
- Function to detect abnormal heating and temperature sensor errors comes standard.
- Light and compact
- Greatly reduced vibration and operating noise when compared with the refrigerated type.

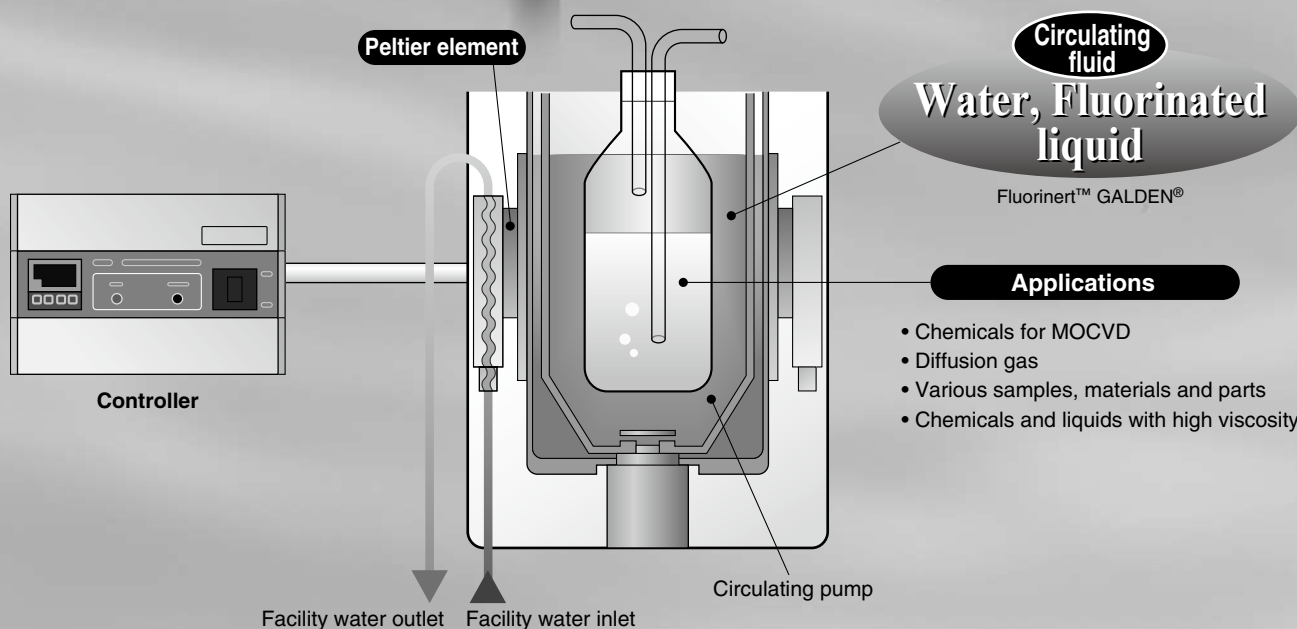
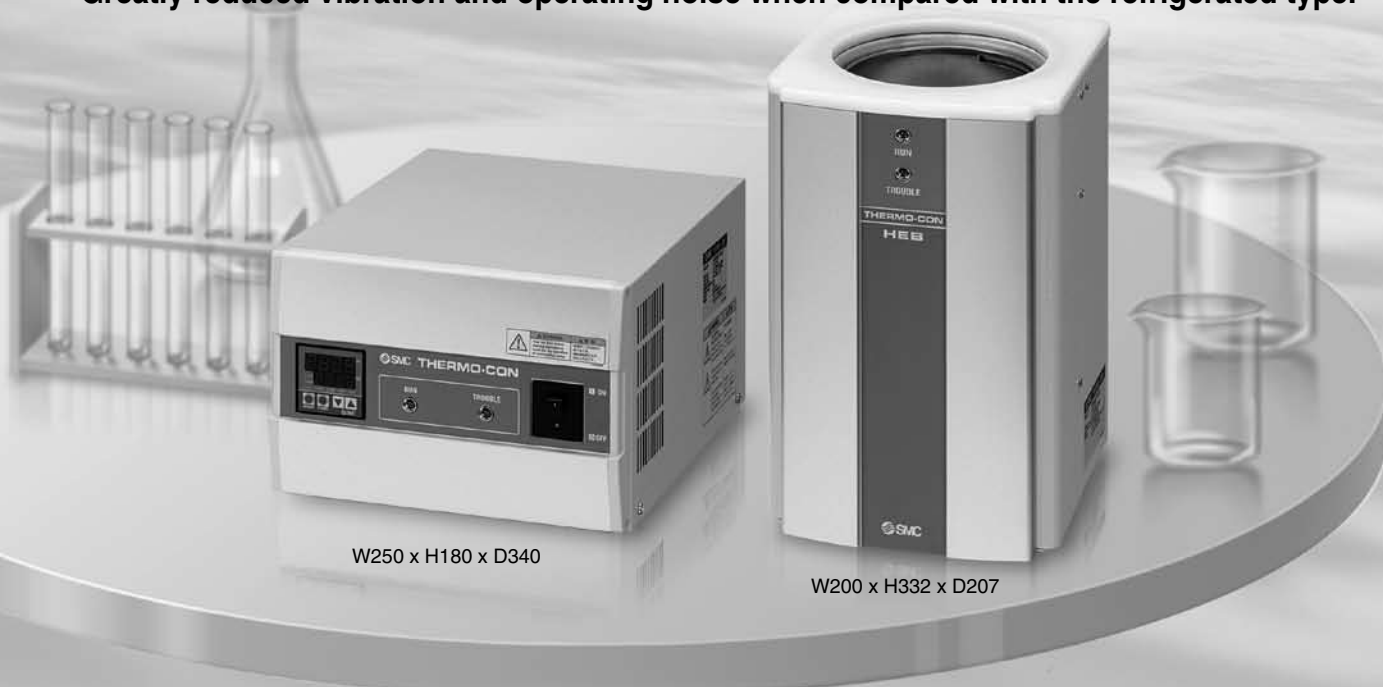

HRG
HRS
HRZ
HRZD
HRW
HEC
HEB
HED
Technical Data
Related Products

Features

Exclusively developed dual tank construction to provide consistent temperature at any position in the bath

Peltier element
(Thermo-module,
Thermoelectric
device)

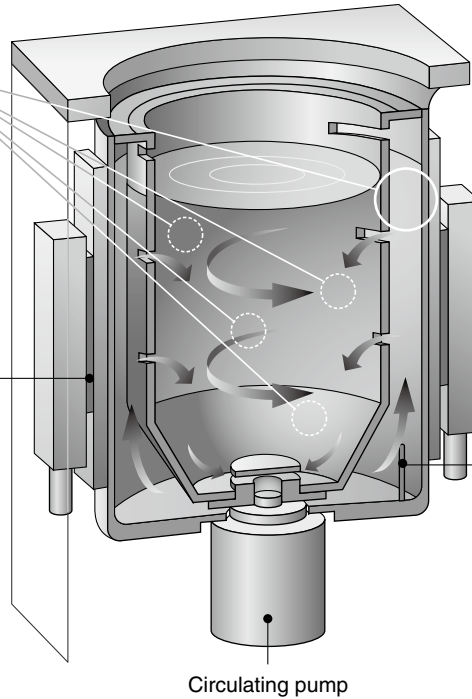

Temperature sensor

- Accurate display by measuring the circulating fluid with a temperature sensor directly

Circulating pump

Application Examples

Semiconductor

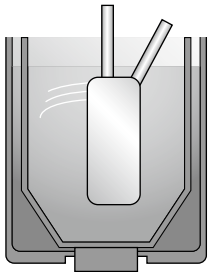

Evaporation of chemicals
for MOCVD
Temperature control of
diffusion gas

Various tests

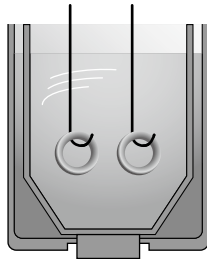

Thermal test with immersion

Physical and chemical analysis

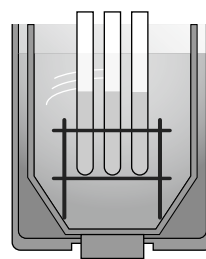

Temperature control of
various samples,
materials and parts

Various chemical processes

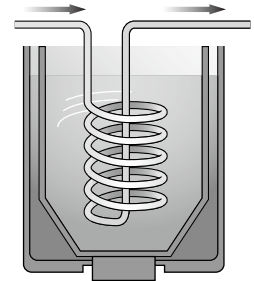

Indirect temperature control of
chemicals and liquids
with high viscosity

Principle of Peltier Device (Thermo-module, Thermoelectric device)

A Peltier device (thermo-module, thermoelectric device) is a plate type element, inside which P-type semiconductors and N-type semiconductors are located alternately. If direct current is supplied to the Peltier device, heat is transferred inside the device, and one face generates heat and increases temperature while the other face sucked heat and decreases temperature. Therefore, changing the direction of the current supplied to the Peltier device can achieve heating and cooling operation. This method has a fast response and can shift quickly between heating and cooling, so temperature can be controlled very precisely.

Cooling

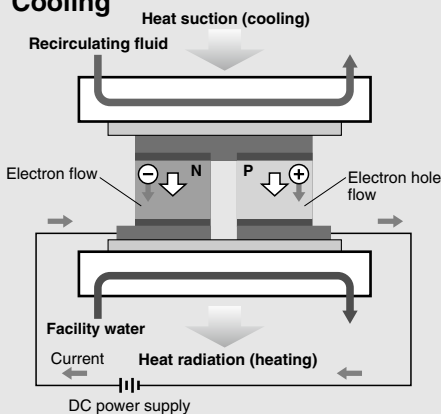

Heating

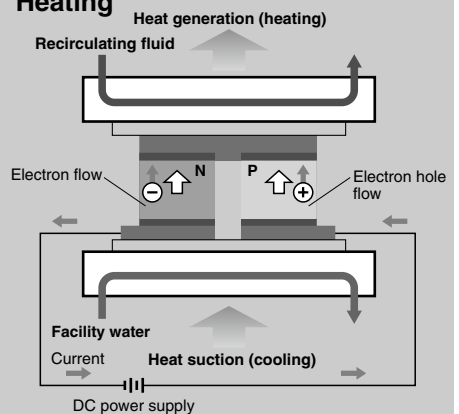

Peltier-Type Thermoelectric Bath Series *HEB*

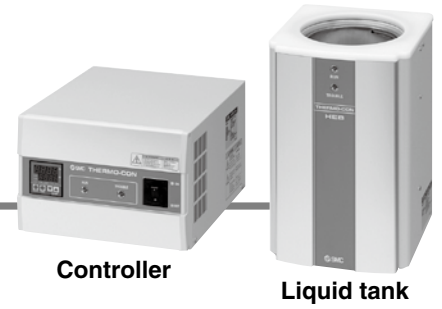

How to Order

Combination (Controller + Liquid tank)

HEB C 002 - W A 10 -

Shape of bath

C	Round
---	-------

Cooling capacity

002	140 W
-----	-------

Radiating method

W	Water-cooled
---	--------------

Option

Nil	Rc1/4
N	NPT1/4

* The option should be specified when ordering.

Liquid tank size

10	ø130 x H180
----	-------------

Communication

A	RS-485
B	RS-232C

Liquid tank

HEB C 002 - H W 10 -

Shape of bath

C	Round
---	-------

Cooling capacity

002	140 W
-----	-------

Liquid tank

Radiating method

W	Water-cooled
---	--------------

Option

Nil	Rc1/4
N	NPT1/4

* The option should be specified when ordering.

Liquid tank size

10	ø130 x H180
----	-------------

Controller

HEBC002 - C A

Controller

Communication

A	RS-485
B	RS-232C

HRG
 HRS
 HRZ
 HRZD
 HRW
 HEC
HEB
 HED
 Technical Data
 Related Products

Series HEB

Specifications (For details, please consult our “Product Specifications” information.)

Model		HEBC002-WA10	HEBC002-WB10
Cooling method		Peltier device (Thermo-module, Thermoelectric device)	
Radiating method		Liquid tank: Water-cooled, Controller: Forcible air-cooled	
Control method		Cooling/Heating automatic shift PID control	
Ambient temperature/humidity		10 to 35°C, 35 to 80%RH	
Circulating fluid system	Application fluid <small>Note 1)</small>	Clear water, Fluorinated liquid (Fluorinert™ FC-3283, GALDEN® HT135, HT200)	
	Set temperature range <small>Note 1) Note 5)</small>	-15.0 to 60.0°C (5 to 60°C for water)	
	Cooling capacity <small>Note 2)</small>	140 W (Water)	
	Heating capacity <small>Note 2)</small>	300 W (Water)	
	Temperature stability <small>Note 3)</small>	±0.01°C	
	Temperature distribution <small>Note 3)</small>	±0.02°C	
	Tank dimensions	Internal diameter ø130 x Liquid level 188 mm	
Facility water system	Temperature	10 to 35°C (no condensation)	
	Pressure range	Within 0.5 MPa	
	Flow rate <small>Note 4)</small>	3 to 5 L/min	
	Port size	IN/OUT: Rc1/4	
	Wetted parts material	Stainless steel 303, Stainless steel 304, FEP, A6063 (anodized)	
Electrical system	Power supply	Single-phase 100 to 240 VAC, 50/60 Hz	
	Overcurrent protector	10 A	
	Current consumption	4 A (100 VAC) to 2 A (240 VAC)	
	Alarm (With alarm output connector)	1) Overheating of liquid tank (which activates the thermostat) 2) Controller output voltage reduction 3) Controller fan rotation stopped	
Communications		RS-485	RS-232C
Weight		Liquid tank: Approx. 8.5 kg Controller: Approx. 6.5 kg	
Accessories		Power cable (2 m), DC cable, Signal cable (3 m each)	
Safety standards		CE marking, UL (NRTL) standard	

Note 1) GALDEN® is a trademark of Solvay Solexis and Fluorinert™ is a trademark of 3M. For other fluids, please contact SMC.

Note 2) Determined under the following conditions: water as the recirculating fluid, set temperature 25°C, facility water temperature 25°C, flow rate 3 L/min, ambient temperature 25°C, and sealed from outside air with a lid.

Note 3) Differs depending on the operating conditions.

Note 4) An appropriate range is from 3 to 5 L/min. To prevent damage to the radiating system, do not supply a flow over the maximum flow rate of 8 L/min.

Note 5) When the temperature is set high, the liquid temperature inside of the liquid tank and the temperature inside of the thermostat could differ greatly depending on the heating mode at start-up, and the thermostat could then begin operating and stop the output. Confirm that there is no problem by carrying out an operating test beforehand.

Cooling Capacity

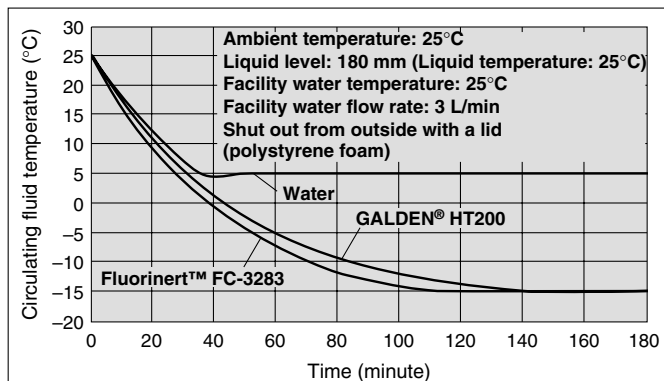

Heating Capacity

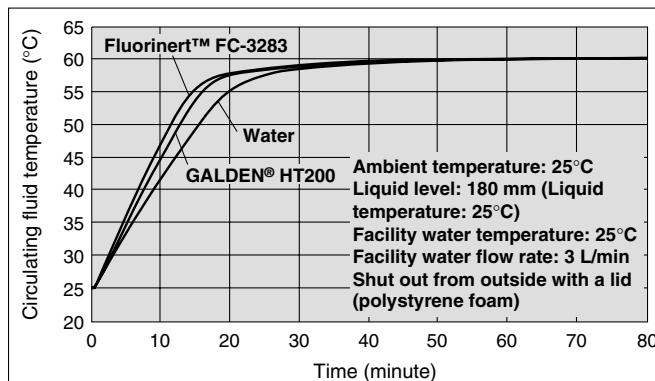

Pressure Loss in Facility Water Circuit

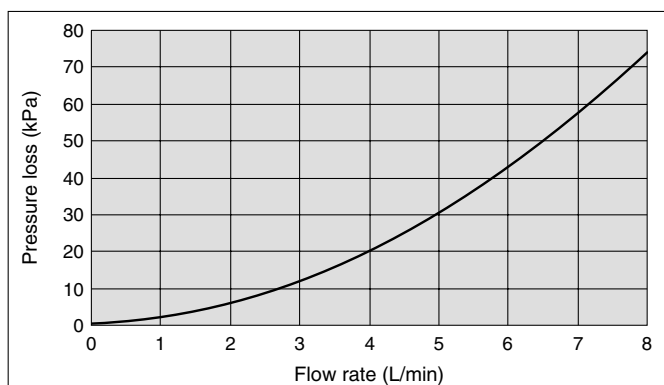

The values shown on the performance chart are not guaranteed, but typical. Allow margins for safety when selecting the model.

Parts Description

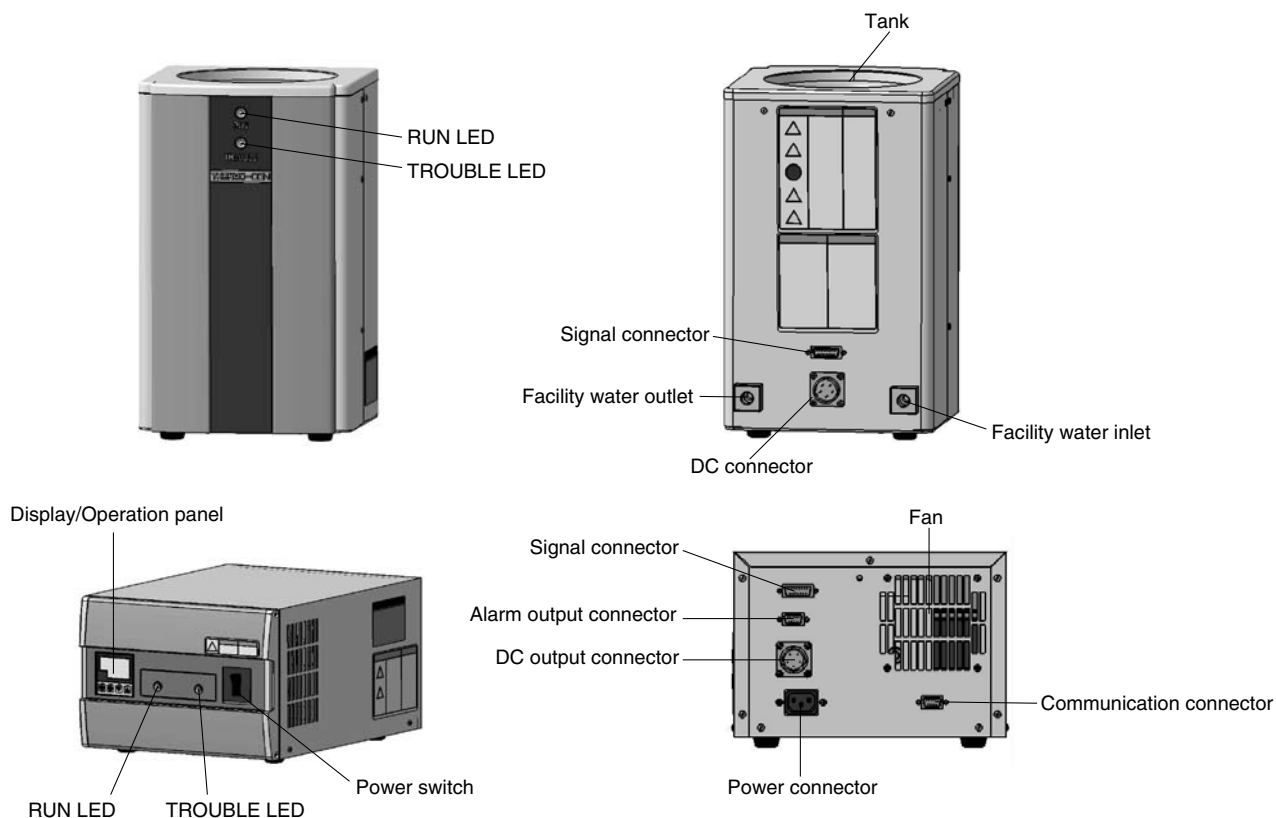

HRG

HRS

HRZ

HRZD

HRW

HEC

HEB

HED

Technical Data

Related Products

Series HEB

Dimensions

Liquid tank

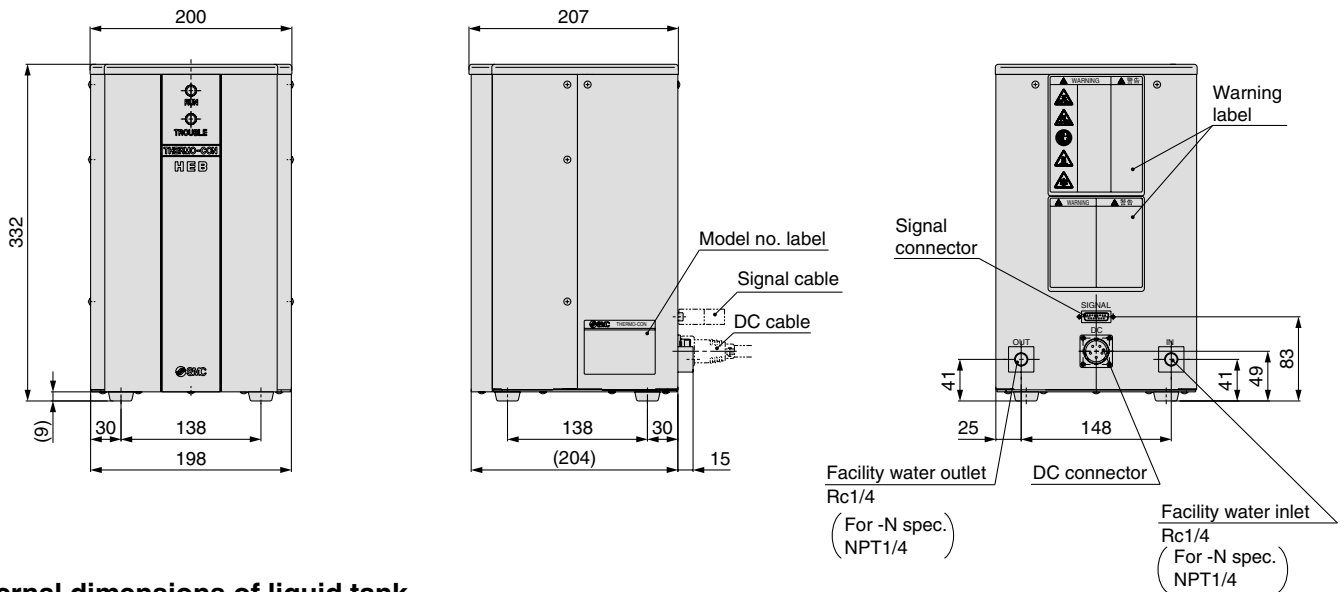

Internal dimensions of liquid tank

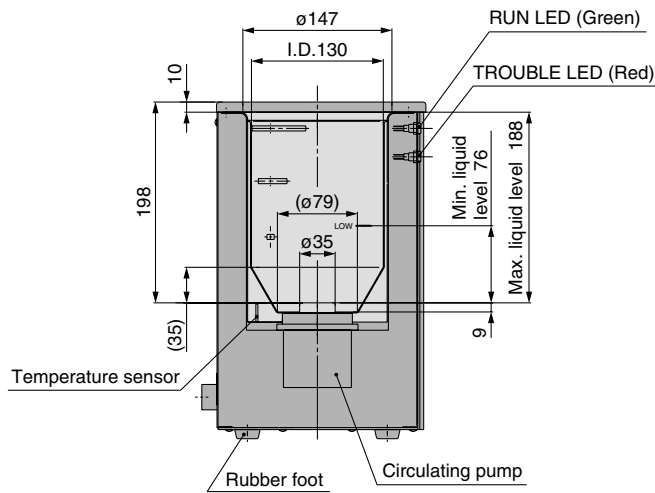

Controller

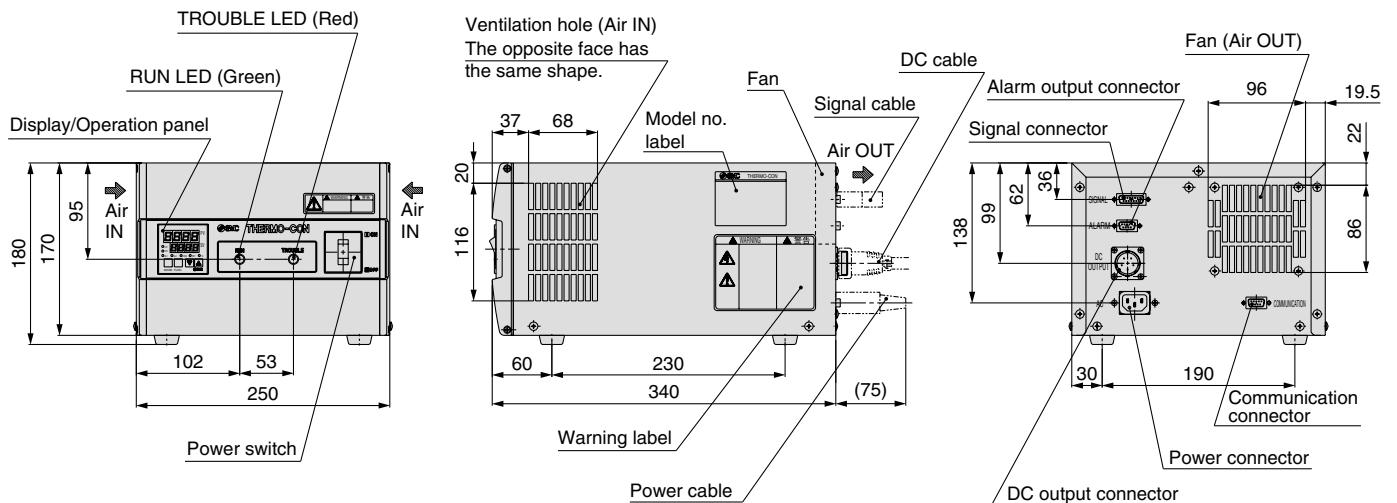

Connectors

Water Bath and Controller Connection

■ Connector for water baths

DC connector (male connector)	Signal connector (male connector)
Nanaboshi Electric Mfg. Co., Ltd.: NJC-245-RM UL CSA	Hirose Electric Co., Ltd.: CDA-15P Holding screw M2.6



■ Connection cable

DC cable	Signal cable
Nanaboshi Electric Mfg. Co., Ltd.: NJC-245-PF UL CSA Female connector	Hirose Electric Co., Ltd.: CDA-15S Holding screw M2.6 Female connector
Male connector Nanaboshi Electric Mfg. Co., Ltd.: NJC-245-PM UL CSA	Male connector Hirose Electric Co., Ltd.: CDA-15P Holding screw M2.6



■ Connector for controllers

DC connector (female connector)	Signal connector (female connector)
Nanaboshi Electric Mfg. Co., Ltd.: NJC-245-RF UL CSA	Hirose Electric Co., Ltd.: CDA-15S Holding screw M2.6

Power Cable Connection

■ Connector for controllers

Power connector
IEC 60320 C-14 or equivalent Male connector



■ Power cable

Connector side
IEC 60320 C-13 or equivalent Female connector
AWG14
Signal contents
Black 1 100 to 240 VAC (L)
Black 2 100 to 240 VAC (N)
Green/Yellow PE

Connector for External Equipment

Connectors that fit with a communication connector and an alarm output connector should be prepared by customer.

■ Alarm output connector

Hirose Electric Co., Ltd.: CDE-9P
Holding screw M2.6
Fitting connector: CDE-9S or equivalent

Pin No.	Signal contents
1	Contact for upper/lower temperature limit deviation alarm (open when alarm occurs)
2	Upper/lower temperature limit deviation alarm common
3-4	Unused
5	Contact for output cut-off alarm (open when alarm occurs)
6	Common for output cut-off alarm
7-9	Unused

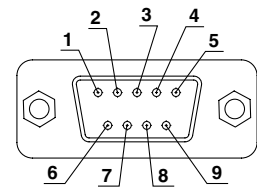

Alarm output connector
D-sub 9 pin (male type)

■ Communication connector

Hirose Electric Co., Ltd.: CDE-9S
Holding screw M2.6
Fitting connector: CDE-9P or equivalent

Pin No.	Signal contents	
	HEBC002-WA10	HEBC002-WB10
1	RS-485 T/R (A)	Unused
2	RS-485 T/R (B)	RS-232C RX
3	Unused	RS-232C TX
4	Unused	Unused
5	Unused	RS-232C SG
6-9	Unused	Unused

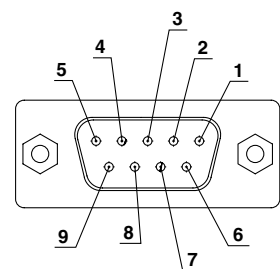

Communication connector
D-sub 9 pin (female type)

Maintenance

Maintenance of this unit is performed only in the form of return to and repair at SMC's site. As a rule, SMC will not conduct on-site maintenance. Separately, the following parts have a limited life and need to be replaced before the life ends.

Parts Life Expectation

Description	Expected life	Possible failure
Circulating pump	3 to 5 years	The circulating fluid cannot be fed due to worn bearing and/or insufficient capacity of electrolytic capacitor, which results in temperature controlling failure.
Fan	5 to 10 years	The capacity of the fan lowers due to the end of lubricating performance of the bearing, which results in increase of internal temperature of the Controller. The overheat protective function at the inside of the power supply starts, the output stops and the display goes off.
DC power supply	5 to 10 years	Abnormal voltage is generated and the display goes off due to insufficient capacity of electrolytic capacitor.

HRG
 HRS
 HRZ
 HRZD
 HRW
 HEC
 HEB
 HED
 Technical Data
 Related Products



Series HEB Specific Product Precautions 1

Be sure to read this before handling. Refer to back page 1 for Safety Instructions and back pages 2 to 5 for Temperature Control Equipment Precautions.

System Design

Warning

1. The catalog shows the specifications of the Thermoelectric Bath.

1. Check detailed specifications in the separate "Product Specifications", and evaluate the compatibility of the Thermoelectric Bath with customer's system.
2. The Thermoelectric Bath is equipped with a protective circuit independently, but the whole system should be designed by the customer to ensure safety.

Handling

Warning

1. Thoroughly read the Operation Manual.

Read the Operation Manual completely before operation, and keep this manual available whenever necessary.

Operating Environment/Storage Environment

Warning

1. Avoid using the Thermoelectric Bath in an environment where it could be splashed by fluids (including mist) such as water, salt water, oil, chemicals, or solvents.

2. The Thermoelectric Bath is not designed for clean room usage.

It generates dust from the pump inside the tank and the cooling fan in the controller.

3. Low molecular siloxane can damage the contact of the relay.

Use the Thermoelectric Bath in a place free from low molecular siloxane.

4. Reserve a space of 50 mm or more at the ventilation hole of the controller.

Radiation Air

Caution

1. The ventilation hole for radiation air must not be exposed to particles and dust as far as possible.

2. Do not let the inlet and outlet for radiation air get closed.

If radiation is prevented, the internal power supply will overheat, causing the protective circuit to be activated and stopping the Thermoelectric Bath.

3. If more than one Thermoelectric Bath is used, consider their arrangement so that the downstream sides of the Thermoelectric Bath suck radiation air from the upstream sides.

Circulating Fluid

Caution

1. Do not use fluids other than those described in the specification.

Otherwise, the pump will be overloaded and may break. If such a fluid is used, please contact SMC beforehand.

2. The Thermoelectric Bath must not be operated without circulating fluid.

The pump breaks by empty driving.

3. The circulating fluid may evaporate, lowering the level in the tank.

Significant reduction of the fluid level can break the circulating pump as well as causing the performance to deteriorate. Use with appropriate liquid level at all times.

Circulating Fluid

Caution

4. The pump can be broken by foreign objects entering the circulating pump.

Control to prevent any foreign object from entering the fluid. If the fluid is fluorinated liquid and it is set to a temperature below freezing point, steam from the atmosphere will form ice (frost) when entering the fluid. Be sure to remove this ice (frost) regularly.

5. If water is used for the circulating fluid, set its temperature to over or more 5°C to prevent it from being frozen.

6. Clear Water (as Circulating Water) Quality Standards

Facility Water Quality Standard

The Japan Refrigeration and Air Conditioning Industry Association

JRA GL-02-1994 "Cooling water system – Circulation type – Make-up water"

	Item	Unit	Standard value	Influence	
				Corrosion	Scale generation
Standard item	pH (at 25°C)	—	6.0 to 8.0	○	○
	Electrical conductivity (25°C)	[μS/cm]	100* to 300*	○	○
	Chloride ion (Cl ⁻)	[mg/L]	50 or less	○	
	Sulfuric acid ion (SO ₄ ²⁻)	[mg/L]	50 or less	○	
	Acid consumption amount (at pH4.8)	[mg/L]	50 or less		○
	Total hardness	[mg/L]	70 or less		○
	Calcium hardness (CaCO ₃)	[mg/L]	50 or less		○
Reference item	Ionic state silica (SiO ₂)	[mg/L]	30 or less		○
	Iron (Fe)	[mg/L]	0.3 or less	○	○
	Copper (Cu)	[mg/L]	0.1 or less	○	
	Sulfide ion (S ₂ ⁻)	[mg/L]	Should not be detected.	○	
	Ammonium ion (NH ₄ ⁺)	[mg/L]	0.1 or less	○	
	Residual chlorine (Cl)	[mg/L]	0.3 or less	○	
	Free carbon (CO ₂)	[mg/L]	4.0 or less	○	

* In the case of [MΩ·cm], it will be 0.003 to 0.01.

○: Factors that have an effect on corrosion or scale generation.

• Even if the water quality standards are met, complete prevention of corrosion is not guaranteed.

Facility Water

Caution

1. The maximum operating pressure of facility water is 0.5 MPa.

If this value is exceeded, the internal piping of the tank can break, causing leakage of facility water.

2. Do not supply a flow rate of 8 L/min or more which can break the facility water piping.

3. Appropriate range of the flow rate of the facility water is 3 to 5 L/min.

Flow rate higher than this range will not slightly affect the cooling and heating capacity. However, a flow rate below 3 L/min will reduce the cooling and heating capacity significantly.

Communication

Caution

1. The set value can be written to EEPROM, but only up to approx. 100,000 times.

In particular, pay attention to how many of times the writing is performed using the communication function.



Series *HEB* Specific Product Precautions 2

Be sure to read this before handling. Refer to back page 1 for Safety Instructions and back pages 2 to 5 for Temperature Control Equipment Precautions.

Maintenance

Warning

1. Prevention of electric shock and fire

Do not operate the switch with wet hands. Also, do not operate the Thermoelectric Bath with water or fluid left on it.

2. Action in the case of error

If any error such as abnormal sounds, smoke, or bad smell occurs, cut off the power at once, and stop supplying facility water. Please contact SMC or a sales distributor to repair the Thermoelectric Bath.

3. Regular inspection

Check the following items at least once a month. The inspection must be done by an operator who has sufficient knowledge and experience.

- a) Check of displayed contents.
- b) Check of temperature, vibration and abnormal sounds in the body of the Thermoelectric Bath.
- c) Check of the voltage and current of the power supply system.
- d) Check for leakage and contamination of the recirculating fluid and intrusion of foreign objects to it.
- e) Check radiation air flow condition and temperature.
- f) Check for leakage, quality change, flow rate and temperature of facility water.

HRG
HR S
HR Z
HR ZD
HR W
HEC
HEB
HED
Technical Data
Related Products